

DESCRIPTION

CS1-RS economic type Resistance Indicator has been designed with high accuracy measurement, display and communication of Ohm(2 wire) as like as Coil of motor or transformer.

☑ The meter supports Field Calibration function. It can be calibrated with sensor (Resistance) to meet machinery structure.

They are also available 1 option of 1 Relay outputs, 1 Analogue output or 1 RS485 (Modbus RTU Mode) interface with versatile functions such as control, alarm, re-transmission or communication for a wide range of machinery and testing equipments applications.



FEATURE

- Measuring resistance 0~200Ω/2000Ω/20.0KΩ/200.0KΩ (2 wire) changeable by dip switch on rear of meter
- Field calibration with resistance to meet the system requirement
- Option available 1 of 1 relay, 1 analogue output or RS485(Modbus RTU mode)
- 1 relay can be programmed individual to be a Hi / Lo / Hi Latch / Lo Latch energized with Start Delay / Hysteresis / Energized & De-energized Delay functions.
- Analogue output or RS 485 communication port in option
- CE Approved & RoHS

APPLICATIONS

- Testing Equipments for resistance (as like as coil of motor, transformer, relay ..) Measuring, Alarm or Communication with PC/PLC.
- Components of resistance online testing station.

ORDERING INFORMATION

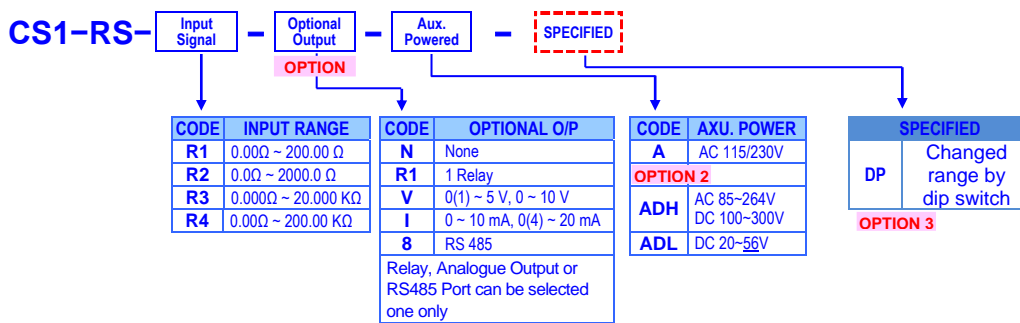

TECHNICAL SPECIFICATION

Input	
Measuring Range	Input Impedance
0.0 Ω ~ 200.00 Ω (2 wire)	≥1M ohm
0.0 Ω ~ 2000.0 Ω (2 wire)	
0.00 Ω ~ 20.000 KΩ (2 wire)	
0.00 Ω ~ 200.00 KΩ (2 wire)	

▶ Above ranges can be changed by dip switch on rear of meter.

- Calibration:** Digital calibration by front key
- Field calibration:** Calibration with sensor input high & low to meet system structure. And field calibration reset is not change the accuracy & linear of factory calibration.
- A/D converter:** 16 bits resolution
- Accuracy:** ≤± 0.04% of FS ± 1C;
- Sampling rate:** 15 cycles/sec
- Response time:** ≤100 m-sec.(when the AvG = "1") in standard

Display & Functions

- LED:** Numeric: 5 digits, 0.8"(20.0mm)H red high-brightness LED
 Relay output indication: 1 square red LED
 RS 485 communication: 1 square orange LED
 E.C.I. function indication: 1 square green LED
 Max/Mini Hold indication: 2 square orange LED
 Down key function indication (Reset for Max.(Mini.) Hold / PV Hold / Relative PV): 1 square green LED
- Display range:** -19999~29999;

- Scaling function:** LoSC : Low Scale; Settable range: -19999~+29999
 Hi SC : High Scale; Settable range: -19999~+29999
 Programmable from 0 / 0.0 / 0.00 / 0.000 / 0.0000
- Decimal point:** 0.0FL, when input is over 20% of input range
 Hi - 0.0FL, when input is under -20% of input range
 Lo Maximum and Minimum value storage during power on.
- Over range indication:** PV / Max(Mini) Hold / RS 485 Programmable
- Under range indication:** Relative PV / PV Hold / Reset for maxi(mini) hold / Reset for relay energized latch programmable
- Max / Mini recording:** Settable range: -19999~29999 counts
- Display functions:** P.u.P.r.o : Settable range: -19999~+29999
 P.u.S.P.n : Settable range: -19999~+29999
- Front key functions:**
- Low cut:**
- Digital fine adjust:**

Reading Stable Function

- Average:** Settable range: 1~99 times
- Moving average:** Settable range: 1(None)~10 times
- Digital filter:** Settable range: 0(None)/1~99 times

Control Functions(option)

- Set-points:** One set-point
- Control relay:** 1 Relay, FORM-C, 5A/230Vac, 10A/115V
- Relay energized mode:** Energized levels compare with set-points:
 Hi / Lo / Hi.HLd / Lo.HLd programmable
- Energizing functions:** Start delay / Energized & De-energized delay / Hysteresis / Energized Latch
- Start band**(Minimum level for Energizing): 0~9999counts
- Start delay time:** 0:00.0~9(Minutes):59.9(Second)
- Energized delay time:** 0.00.0~9(Minutes):59.9(Second)
- De-energized delay time:** 0.00.0~9(Minutes):59.9(Second)
- Hysteresis:** 0~5000 counts



Analogue output(option)

Accuracy:	±0.1% of F.S.;
Ripple:	≤±0.1% of F.S.
Response time:	≤100 m-sec. (10~90% of input)
Isolation:	AC 2.0 KV between input and output
Output range:	Specify either Voltage or Current output in ordering Voltage: 0~5V / 0~10V / 1~5V programmable Current: 0~10mA / 0~20mA / 4~20mA programmable
Output capability:	Voltage: 0~10V: ≥ 1000Ω; Current: 4(0)~20mA: ≤ 500Ω max
Functions:	R_oH5 (output range high): Settable range: -19999~29999 R_oL5 (output range Low): Settable range: -19999~29999
Digital fine adjust:	R_oP_ro : Settable range: -38011~+27524 R_oS_Pn : Settable range: -38011~+27524

DIMENSIONS

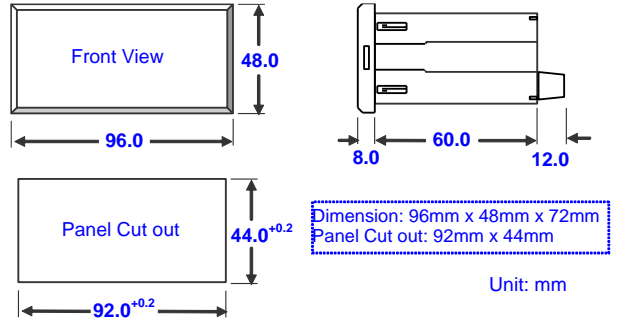

INSTALLATION

The meter should be installed in a location that does not exceed the

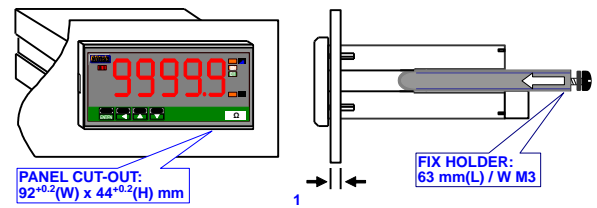

CONNECTION DIAGRAM

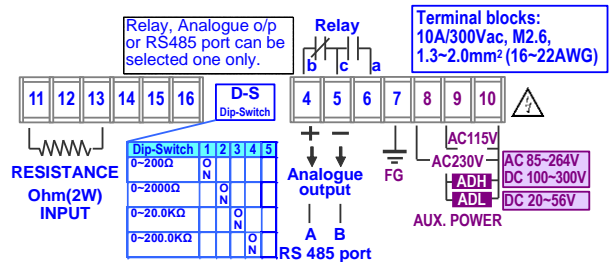

Please check the voltage of power supplied first, and then connect to the specified terminals. It is recommended that power supplied to the meter be protected by a fuse or circuit breaker.

Power Supply

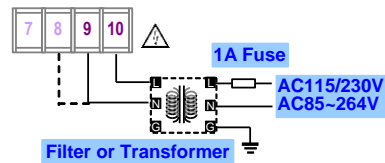

RS485 Communication Port

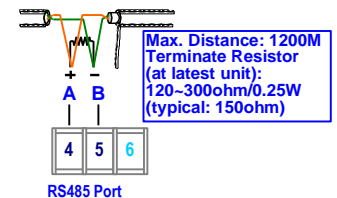

RS 485 Communication(option)

Protocol:	Modbus RTU mode
Baud rate:	1200/2400/4800/9600/19200/38400 programmable
Data bits:	8 bits
Parity:	Even, odd or none (with 1 or 2 stop bit) programmable
Address:	1 ~ 255 programmable
Remote display:	to show the value from RS485 command of master
Distance:	1200M
Terminate resistor:	150Ω at last unit.

Electrical Safety

Dielectric strength:	AC 2.0 KV for 1 min, Between Power / Input / Output / Case
Insulation resistance:	≥100M ohm at 500Vdc, Between Power / Input / Output
Isolation:	Between Power / Input / Relay, Analogue, RS485
EMC:	EN 55011:2002; EN 61326:2003
Safety(LVD):	EN 61010-1:2001

Environmental

Operating temp.:	0~60 °C
Operating humidity:	20~95 %RH, Non-condensing
Temp. coefficient:	≤100 PPM/°C
Storage temp.:	-10~70 °C
Enclosure:	Front panel: IEC 529 (IP52); Housing: IP20

Mechanical

Dimensions:	96mm(W) x 48mm(H) x 72mm(D)
Panel cutout:	92mm(W) x 44mm(H)
Case material:	ABS fire-resistance (UL 94V-0)
Mounting:	Panel flush mounting
Terminal block:	Plastic NYLON 66 (UL 94V-0) 10A 300Vac, M2.6, 1.3~2.0mm ² (16~22AWG)
Weight:	350g

Power

Power supply:	AC115/230V,50/60Hz; Optional: AC 85~264V / DC 100~300V or DC 20~56V
Excitation supply:	DC 5/10V, 30mA maximum in standard
Power consumption:	3.0VA maximum ADH/ADL: 8VA/4.0W
Back up memory:	By EEPROM

FRONT PANEL

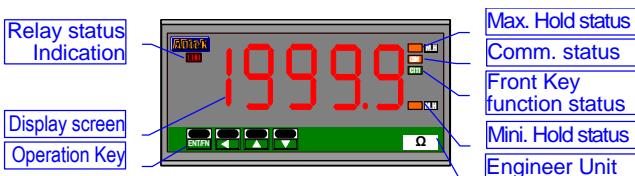

FUNCTION DESCRIPTION

Input & Scaling Functions

Scaling function:

Setting the [LoSC] (Low scale) and [HiSC] (High scale) in [INPUT GROUP] to relative input signal. **Reverse scaling will be done too.** Please refer to the figure as below,

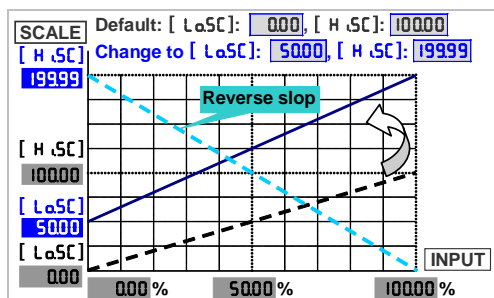

Display & Functions

Max / Mini recording:

The meter will store the maximum and minimum value in [user level] during power on in order to review drifting of PV.

Display functions: PV / Max(Mini) Hold / RS 485 programmable in [dSPLY] function of [INPUT GROUP]

Present Value [PV]: The display will show the value that Relative to Input signal.

Maximum Hold [HrHld] / Minimum Hold [LrHld]:

The meter will keep display in maximum (minimum) value during power on, until press front key to reset (If the down key function in [INPUT GROUP] has been set to [rSE]).

- ▶ Please find the [MI] sticker that enclosure the package of the meter to stick on the right side of square orange LED

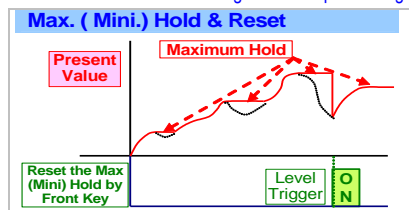

Remote Display by RS485 command [F5485]:

The meter will show the value that received from RS485 sending. In past, The meter normally receive 4~20mA or 0~10V from AO or digital output from BCD module of PLC. We support a new solution that PV shows the value from RS485 command of master can so that can be **save cost and wiring** from PLC.

Front key functions:

Relative PV / PV Hold / Reset for maxi(mini) hold / Reset for relay energized latch programmable in [dRELAY] function of [INPUT GROUP]

Relative PV [ELPu]: The [dRELAY] function can be set to be [ELPu] function.

(Tare function)

When user presses the [key], the display will show the differential value (Δ PV), until press [key] again.

- ▶ Please find the [RPU] sticker to stick on the right side of square green LED.

PV Hold [PwHld]:

The [dRELAY] function can be set to be [PwHld] function.

When user presses the [key], the display will be hold until press the [key] again.

- ▶ Please find the [PWA] sticker to stick on the right side of square green LED.

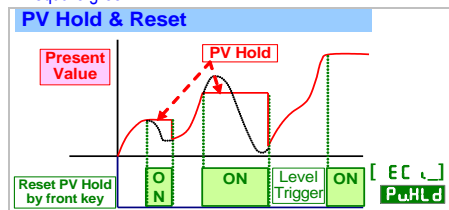

Reset for Max(Mini) Hold [rSE]:

when the [dSPLY] in [INPUT GROUP] set to be [HrHld] or [LrHld], [dRELAY] function can be set to be [rSE] to reset the display when it is holding in maxi or mini value.

Max. (Mini) Hold & Reset

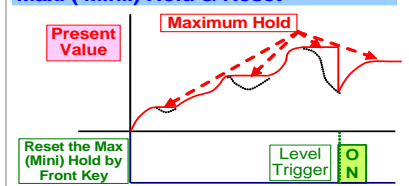

Reset for relay energized latch [rSE]:

when the [rY lnd] in [RELAY GROUP] set to be [HrHld] or [LrHld], [dRELAY] function can be set to be [rSE] to reset the relay when it is energizing and latching.

Hi or Lo Energized Latch & Reset

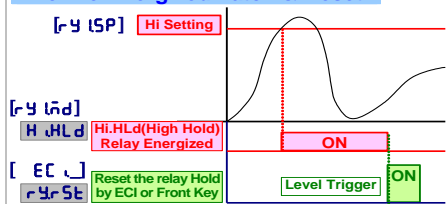

Low cut:

If the setting value is positive, it means when the absolutely value of PV \leq Setting value, the display will be 0. If the setting value is negative, it means when the PV under setting value (PV \leq -Setting value), the display will be setting value.

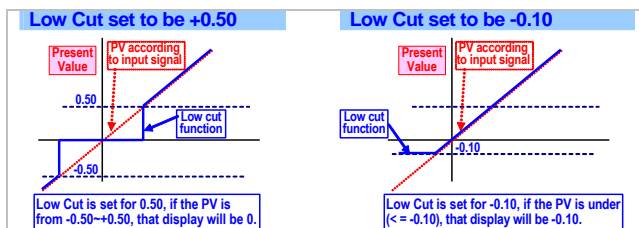

Digital fine adjustment:

Users can get Fine Adjustment for Zero & Span of PV by front key of the meter, and "Just Key In" the value which user want to show in the current input signals.

Especially, the [PwPn] & [PwSpn] are not only in zero & span of PV, but also any lower point for [PwPn] & higher point for [PwSpn]. The meter will be linearization for full scale.

The adjustment can be clear in function [PSCLR]

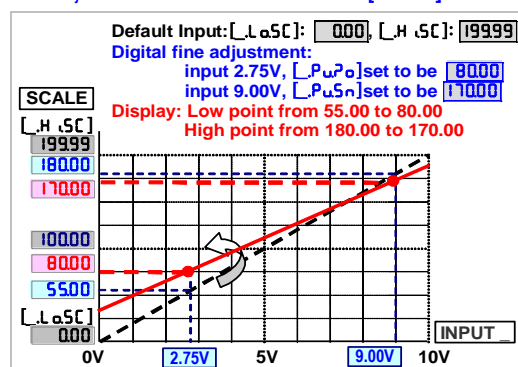

Reading Stable Function

Average:

Basically, the sampling rate of meter is 15cycles/sec. If the function set to be 3 times, It means the meter will update of display will be 5 times/sec.

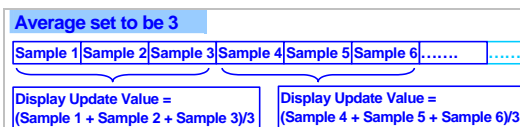

Remark: The higher average setting will cause the response time of Relay and Analogue output slower.

Moving average:

If the function to be set 3 times, the meter will update delay in first 3 samples, then it will update 15 times/sec continuously.

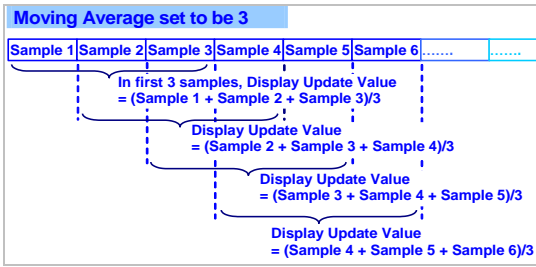

Remark: The higher moving average setting wouldn't cause the response time of Relay and Analogue output slower after first 3 samples.

Digital filter:

The digital filter can reduce the magnetic noise in field.

Control Functions(option)

Relay energized mode:

- Hi / Lo / Hi.HLD / Lo.HLD programmable
- Relay will energize when PV > Set-Point
- Lo [Lo](Fig.1-②): Relay will energize when PV < Set-Point

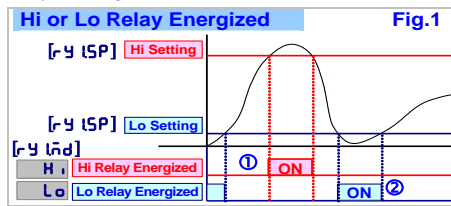

Hi.HLD [H.HLD] (Lo.HLD [Lo.HLD]):

When the PV is Higher (or lower) than set-point, the relay will be energized and latch until manual reset by from key in [user level] or press down key to reset(if the [d] function set to be [d]).

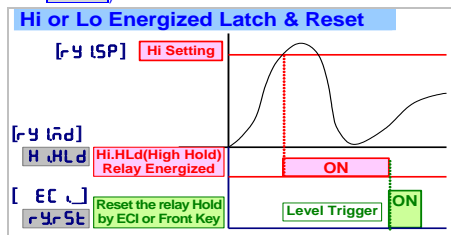

Energized functions:

Start delay / Energized & De-energized delay / Hysteresis

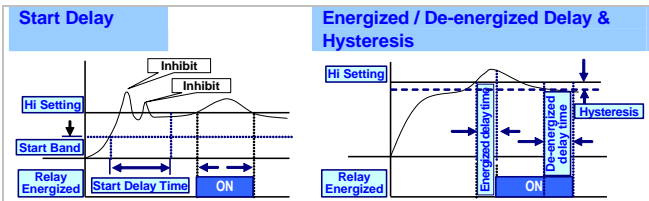

Analogue output(option)

Please specify the output type either an 0~10V or 4(0)~20mA in ordering. The programmable output low and high scaling can be based on various display values. Reverse slope output is possible by reversing point positions.

Output range:

Voltage: 0~5V / 0~10V / 1~5V programmable
Current: 0~10mA / 0~20mA / 4~20mA programmable

Functions:

Output range high [RaHS]: Setting the Display value High to versus output range High(as like as 20mA in 4~20)

Output range low [RaLS]: Setting the Display value Low to versus output range Low(as like as 4mA in 4~20)

Fine zero & span adjustment:

Zero adjust [RaZO]: Fine Zero Adjustment for Analog Output; Settable range: -38011~27524;

Span adjust [RaSPn]: Fine Span Adjustment for Analog Output; Settable range: -38011~27524;

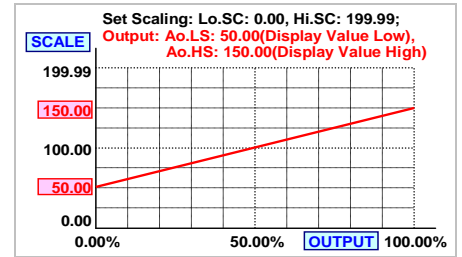

The range between RaHS and RaLS should be over 20% of span at least; otherwise, it will be got less resolution of analogue output.

RS 485 Communication(option)

The RS485's protocol is Modbus RTU mode, and baud rate up to 38400 bps. It's convenience to remote monitoring, display for reading.

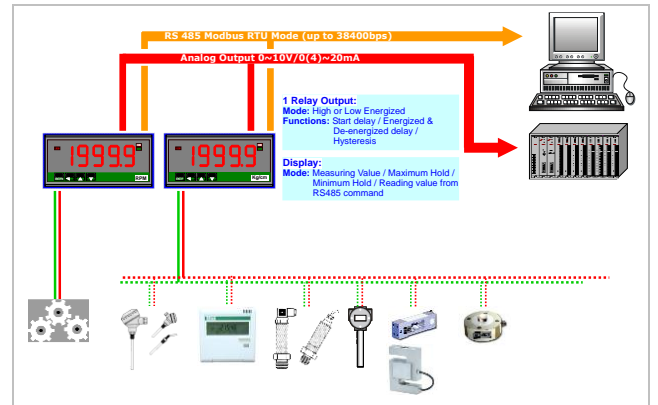

Remote display:

The meter will show the value that received from RS485 command. In past, The meter normally receive 4~20mA or 0~10V from AO or digital output from BCD module of PLC. We support a new solution that PV shows the value from RS485 command of master so that can be **save cost and wiring** from PLC. When the [d5PL] set to be RS485, it means, the PV screen will show the number from RS485 command & data. The data (number) will be same as PV that will compare with set-point, analogue output and ECI functions so that is to control analogue output, relay energized and so on.

Calibration

System calibration by front key. The process of calibration, please refer to the operating manual

Field Calibration

In pass time, engineers have take a lot of time to adjust meters or converter to meet the structure of machinery zero and span for the Load Cell measuring. Now, our CS1-RS support easier process to do it called "Field Calibration".

Optional Function

Customize function with quantities is welcome. Please contact with our sales for detail. The appendix code of optional function will be added behind the code of auxiliary power.

CS1-RS

■ ERROR MESSAGE

BEFORE POWER ON, PLEASE CHECK THE SPECIFICATION AND CONNECTION AGAIN.

SELF-DIAGNOSIS AND ERROR CODE:

DISPLAY	DESCRIPTION	REMARK
ouFL	Display is positive-overflow (Signal is over display range)	(Please check the input signal)
-ouFL	Display is negative-overflow (Signal is under display range)	(Please check the input signal)
ouFL	ADC is positive-overflow (Signal is higher than input 120%)	(Please check the input signal)
-ouFL	ADC is negative-overflow (Signal is lower than input -120%)	(Please check the input signal)
EEP ↔ FAiL	EEPROM occurs error	(Please send back to manufactory for repaired)
R.i.nG ↔ Pu	Calibrating Input Signal do not process	(Please process Calibrating Input Signal)
A.i.C ↔ FAiL	Calibrating Input Signal error	(Please check Calibrating Input Signal)
R.o.u.T ↔ Pu	Calibrating Output Signal do not process	(Please process Calibrating Output Signal)
R.o.C ↔ FAiL	Calibrating Output Signal error	(Please check Calibrating Output Signal)

■ FRONT PANEL:

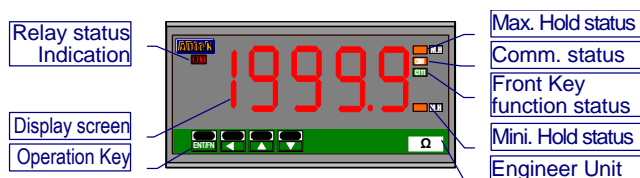

■ Numeric Screens

0.8" (20.0mm) red high-brightness LED for 4 2/3 digital present values.

■ I/O Status Indication

● Relay Energized: 1 square red LED

RL1 display when Relay 1 energized;

● RS485 Communication: 1 square orange LED

COM will flash when the meter is receive or send data, and **COM** flash quickly means the data transient quicker.

● Max/Mini Hold indication: 2 square orange LEDs

M.H displayed: When the display function has been selected in Maximum or Minimum Hold function.

■ Stickers:

Each meter has a sticker what are functions and engineer label enclosure.

● Relay energized mode: **HH HI LO LL DO**

● Down key functions mode:

P.V.H PV.H(PV Hold) / **Tare** Tare / **DI** DI(Digital Input)

M.RS M.RS(Maximum or Minimum Reset) /

R.RS R.RS(Reset for Relay Latch)

● Engineer Label: over 80 types.

■ Operating Key: 4 keys for Enter(Function) / Shift(Escape) / Up key / Down key

■ Pass Word: Settable range:0000~9999;

User has to key in the right pass word so that get into **[Programming level]**. Otherwise, the meter will go back to measuring page. If user forgets the password, please contact with the service window.

■ Function Lock: There are 4 levels programmable.

● None **nonE**: no lock all.

● User Level **USEr**: User Level lock. User can get into User Level for checking but setting.

● Programming Level **EnG**: Programming level lock.

User can get into programming level for checking but setting.

● ALL **ALL**: All lock. User can get into all level for checking but setting.

■ Front Key Function:

● The Key can be set to be **rELPu** / **PuHLd** / **rRS** / **rRS** programmable.

■ OPERATING KEY

*Please access to the Programming Level to check and set the parameters when users start to run the meter

■ Operating Key: 4 keys for Enter(Function) / Shift(Escape) / Up key / Down key

■ The meter has designed operation similar as PC's and . In any page, press key means "enter" or "confirm setting", and press key means "escape(**Esc**)" or "shift".

■ In Programming Level, the screen will return to Measuring Page after do not press any key over 2 minutes, or press for 1 second.

	Function Index	Setting Status
(=) Enter/Fun key	(1) In any page, press to access the level or function index (2) From the function index to access setting status	(3) Setting Confirmed, save to EEPROM and go to next function index
(=) Shift key	(1) In measuring page, press for 1 second to access user level. (2) In function index, press for 1 second to go back upper level. (3) In function group index, press for 1 second to go back measuring page	(4) In setting status, press to Shift the setting position. (5) In setting status, press for 1 second to abort setting and go back this function index.
(=) Up key	(1) In function index, press to go back to previous function index	(2) In setting status for function, press to select function (3) During number Setting, press can roll the digit up
(=) Down key	(1) In Function Index Page, press will go to the next Function Index Page.	(2) In setting status for function, press to select function (3) During number Setting, press can roll the digit down.

■ **OPERATING DIAGRAM** (The detail description of operation, please refer to operating manual.)

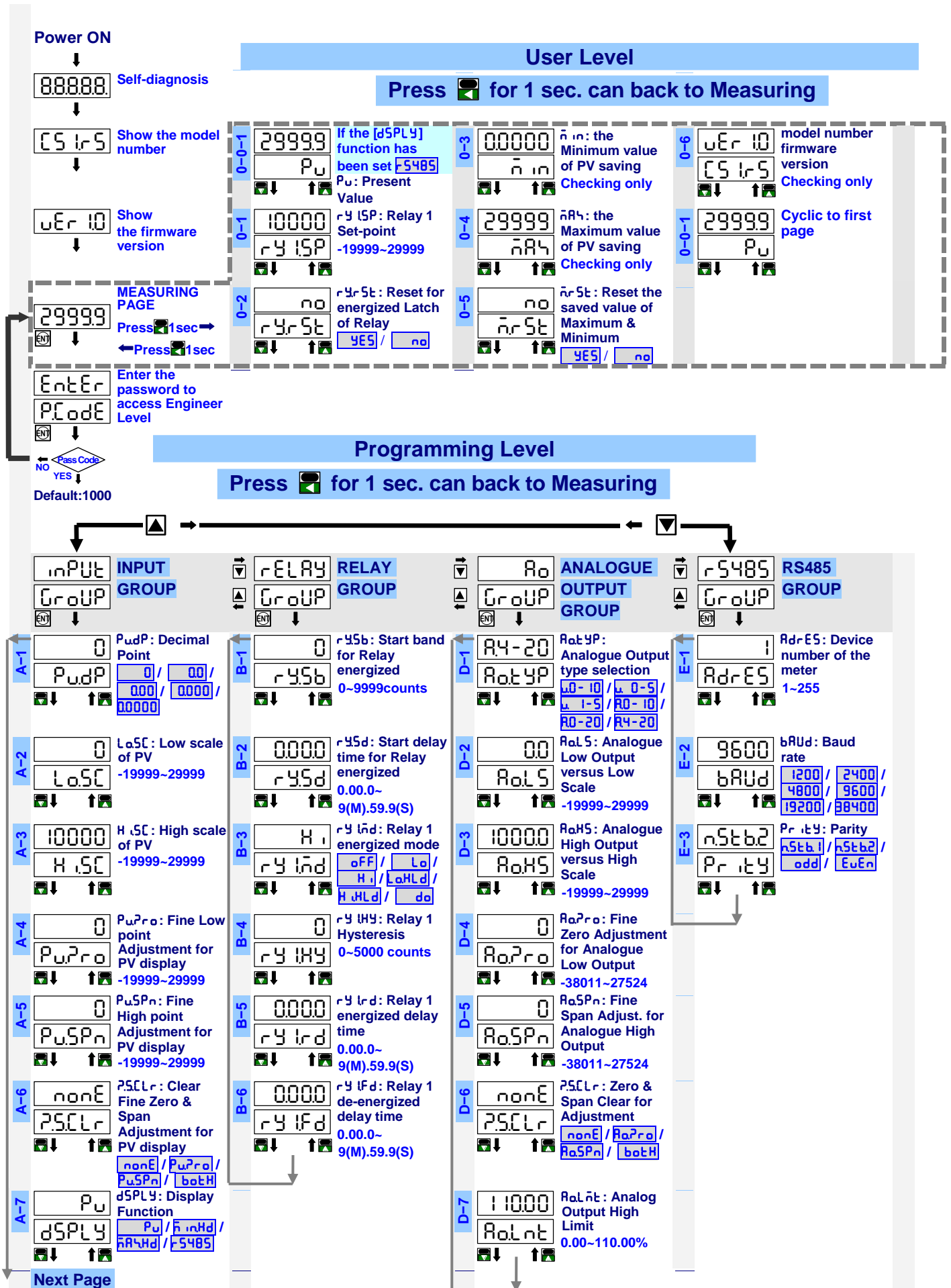

CS1-RS

A-8	LoCut	Low Cut Function -19999~29999
A-9	AUG	Average update for PV 1(None)~99 times
A-10	MAUG	Moving Average update for PV 1(None)~10 times
A-11	dFILT	Digital filter 0(None)/1~99 times
A-12	dnKEY	Down key function nonE / FELD / PuHLd / nrsE / rYrSE
A-13	PCodE	Pass Code for enter Engineer Level 0000~9999
A-14	FLoCY	Function Level Lock nonE / USEr / EnG / ALL

▶ Please refer to operating manual for detail description

FIELD CALIBRATION

MEASURING PAGE

16888

ENTR

PCodE

EntEr

Enter the password to access Programming Level

ENTR

EntEr

Enter the password to access Field Calibration Level

F.CodE

NO

Pass Code

YES

Press ENTR →

default=2000

- Once the user select field calibration, the [LoSC](step A-2) and [HiSC](A-3) will be instead of [CALLS] and [CALHS], and can not to be change. If user has to change the scaling, it's the only way to access field calibration level to set in [CALLS](step F-2) and [CALHS](step F-4).
- Please double check the [LoSC](step A-2) and [HiSC](A-3) are correct after selection the **dEFLd** or **F.iELd**

F-1	CALLo	Adjust the structure to be a lower signal output status (or any lower status) and keep it in stable. CALLo: Field Calibration Low ▶ Press ENTR to read signal of the lower status. ▶ Press ENTR again to finish the calibration lower point, and go to next page.
F-2	CALLS	CALLS: the value to be set is relative to Field Calibration lower point ▶ Press ENTR to set the value of lower scale
F-3	CALHi	Adjust the structure to be a higher signal output status (or any higher status) and keep it in stable. CALHi: Field Calibration High ▶ Press ENTR to read signal of the higher status ▶ Press ENTR again to finish the calibration higher point, and go to next page.
F-4	CALHS	CALHS: the value to be set is relative to Field Calibration higher point ▶ Press ENTR to set the value of Higher scale
F-5	CSEL	CSEL: Calibration parameter selection ▶ Press ENTR to access the function and stand by selection ▶ Press ENTR or ENTR to select (default: dEFLd); Settable: dEFLd / F.iELd dEFLd (default calibration) F.iELd (Field calibration)