

## Description

CS2-SG Strain Gauge Indicator has been designed with high accuracy measurement, display and communication of DC signal 0~1.0/~4.0mV or 0~10.0/~40.0mV as like as Load Cell or Strain Gauge.

The meter supports Field Calibration function. It can be calibrated with sensor(Load Cell/Strain Gauge) to meet machinery structure.

They are also building in 4 Relay outputs, 3 External Control Inputs, 1 Analogue output and 1 RS-485(Modbus RTU Mode) interface with versatile functions such as control, alarm, re-transmission and communication for a wide range of machinery and testing equipments applications.



## Features

- Measuring load cell, strain gauge signal 0~1.0/~2.0/~3.33/~4.0/~10.0/~20.0/~40.0mV/V (Specified)
- Field calibration with load cell or strain gauge to meet the system requirement
- 4 relay can be programmed individual to be a Hi / Lo / Hi Hold / Lo Hold / Go, and can be energized with Start Delay / Hysteresis / Energized & De-energized Delay functions, or to be a remote control.
- Analogue output and RS-485 communication port in option
- 3 external control inputs can be programmed individual to be Tare (Relative PV) / PV Hold / Maximum or Minimum Hold / DI (remote monitoring) / Reset for Relay Energized Latch...
- CE Approved & RoHS

## Applications

- Testing Equipments for weight/force Measuring, Alarm, Control and Communication with PC/PLC
- Leakage testing equipment by tare and relay function.
- Weighting control for packing machine, filling machine.

## Ordering Information

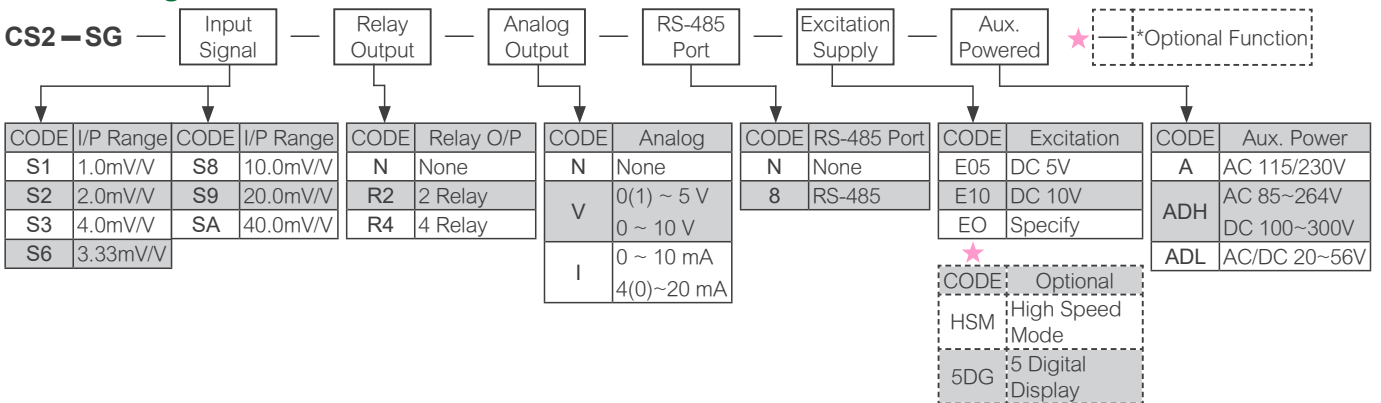

## Technical Specification

### Input

Measuring Range	Input Impedance	Excitation Voltage
0~1.0/~2.0/~3.33/~4.0 mV/V	≥ 1M ohm	DC 5V, 40mA
0~10.0/~20.0/~40.0 mV/V		or DC 10V, 40mA

Calibration: Digital calibration by front key  
 Field calibration: Calibration with sensor input high & low to meet system structure. And field calibration reset is not change the accuracy & linear of factory calibration.  
 A/D converter: 16 bits resolution  
 Accuracy: ≤± 0.04% of F.S. 1C  
 Sampling rate: 15 cycles/sec  
 High speed mode: can be 60cycle/sec(scaling:0~6000)

Response time: ≤ 100 mS (when the AvG = "1" ) in standard  
 Input range: Input High and Low programmable  
 R ,H : Settable range: 0.00~100.00%  
 R ,L : Settable range: 0.00~100.00%

### Display & Functions

LED:  
 Numeric: 5 digits, 0.8"(20.0mm)  
 H red high-brightness LED  
 Relay output indication: 4 square red LED  
 RS-485 communication: 1 square orange LED  
 E.C.I. function indication: 3 square green LED  
 Max/Mini Hold indication: 2 square orange LED  
 Display range: -19999~29999; 5 Digital Display: -19999~99999

Scaling function       $L_{o5\%}$ : Low Scale; Settable range: -19999~+29999/99999  
 $H_{.5\%}$ : High Scale; Settable range: -19999~+29999/99999  
 Decimal point:      Programmable from 0 / 0.0 / 0.00 / 0.000 / 0.0000  
 Over range indication:  $o_{uF L}$ , when input is over 20% of input range Hi  
 Under range indication:  $-o_{uF L}$ , when input is under -20% of input range Lo  
 Max / Mini recording: Maximum and Minimum value storage during power on.  
 Display functions:    PV / Max(Mini) Hold / RS-485 Programmable  
 Front key functions:  Up and down key can be set to be a function as ECI.  
 Low cut: Settable range: -19999~29999 counts  
 Digital fine adjust:    $P_{uP r o}$ : Settable range: -19999~+29999/99999  
 $P_{u5P n}$ : Settable range: -19999~+29999/99999

### Reading Stable Function

Average:              Settable range: 1~99 times  
 Moving average:    Settable range: 1(None)~10 times  
 Digital filter:        Settable range: 0(None)/1~99 times

### Control Functions (optional)

Set-points:            Four set-points  
 Control relay:        Four relays  
                           Relay 2 & Relay 3: Dual FORM-C, 5A/230Vac, 10A/115V  
                           Relay 1 & Relay 4: Dual FORM-A, 1A/230Vac, 3A/115V  
 Relay energized mode: Energized levels compare with set-points:  
                           Hi / Lo / Go.12 / Go.23 / Hi.HLd / Lo.HLd; programmable  
                           DO function: Energized by RS-485 command of master.  
 Energizing functions: Start delay / Energized & De-energized delay /  
                           Hysteresis / Energized Latch  
                           Start band(Minimum level for Energizing): 0~9999counts  
                           Start delay time: 0:00.0~9(Minutes):59.9(Second)  
                           Energized delay time: 0:00.0~9(Minutes):59.9(Second)  
                           De-energized delay time: 0:00.0~9(Minutes):59.9(Second)  
                           Hysteresis: 0~5000 counts

### External Control Inputs (ECI)

Input mode:            3 ECI points, Contact or open collector input, Level trigger  
 Functions:            Relative PV (Tare) / PV Hold / Reset for Max or Mini. Hold / DI / Reset for Relay Energized latch  
 Debouncing time:    Settable range 5 ~255 x (8m seconds)

### Analogue Output (optional)

Accuracy:               $\leq 0.1\%$  of F.S.; 16 bits DA converter  
 Ripple:                 $\leq 0.1\%$  of F.S.  
 Response time:        $\leq 100$  mS (10~90% of input)  
 Isolation:             AC 2.0 KV between input and output  
 Output range:        Specify either Voltage or Current output in ordering  
                           Voltage: 0~5V / 0~10V / 1~5V programmable  
                           Current: 0~10mA / 0~20mA / 4~20mA programmable  
 Output capability:    Voltage: 0~10V;  $\geq 1000\Omega$ ;  
                           Current: 4(0)~20mA;  $\leq 600\Omega$  max  
 Functions:             $R_{oH5}$ : Settable range: -19999~29999/99999  
                            $R_{oL5}$ : Settable range: -19999~29999/99999  
                            $R_{oL n t}$  (output High Limit): 0.00~110.00% of output High  
 Digital fine adjust:   $R_{oP r o}$ : Settable range: -38011~+27524  
                            $R_{o5P n}$ : Settable range: -38011~+27524

### RS-485 Communication (optional)

Protocol:              Modbus RTU mode  
 Address:              1 ~ 247  
 Baud rate:            1200/2400/4800/9600/19200/38400 bps  
 Parity:                None / Even / Odd  
 Data bits:            8 bits  
 Remote display:     To show the value from RS-485 command of master  
 Distance:             1200M max

### Safety

Isolation:             AC 2.5KV, 50/60 Hz, for 1 min  
                           Between Power / Input / Output / Case  
 Insulation resistance:  $\geq 100M \Omega$  @ 500Vdc  
 EMC:                  EN 55011:2002; EN 61326:2003  
 Safety(LVD):        EN 61010-1:2010

### Environmental Conditions

Operating temp.:     0~60°C  
 Operating humidity: 20~95 %RH, Non-condensing  
 Temp. coefficient:    $\leq 100$  PPM/°C  
 Storage temp.:       -10~70°C  
 Enclosure:            Front panel: IEC 529 (IP52); Housing: IP20

### Mechanical Structure

Dimensions:          96mm(W) x 48mm(H) x 120mm(D)  
 Panel cutout:        92mm(W) x 44mm(H)  
 Case material:        ABS fire-resistance (UL 94V-0)  
 Mounting:            Panel flush mounting  
 Terminal block:      Plastic NYLON 66 (UL 94V-0)  
                           10A 300Vac, M2.6, 1.3~2.0mm<sup>2</sup>(16~22AWG)  
 Weight:               550g / 350g(Aux. Power Code: ADH or ADL)

### Power Supply

Power supply:         AC115/230V $\pm 15\%$ , 50/60Hz;  
 Optional:             AC 85~264V, DC 100~300V, AC/DC 20~56V  
 Excitation supply:   DC 5V/10V, 40mA  
 Power consumption: 5.0VA maximum  
 Back up memory:    EEPROM

## Front Panel

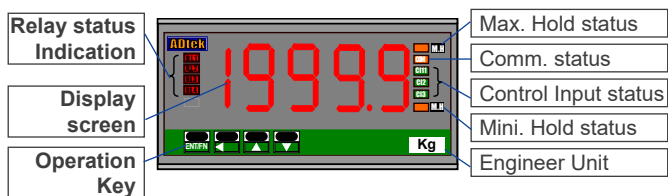

## Dimension

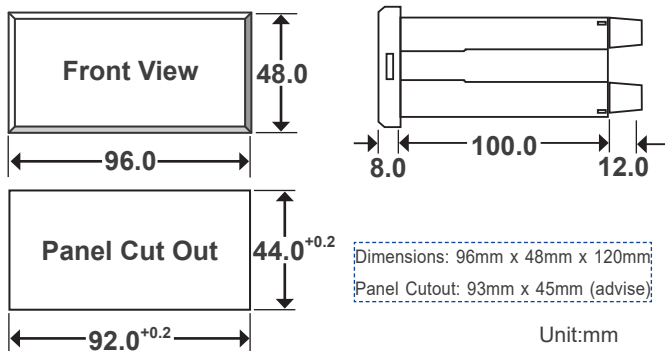

## Installation

The meter should be installed in a location that does not exceed the maximum operating temperature and provides good air circulation.

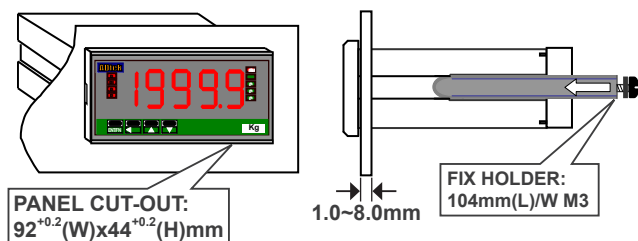

## Pin Assignment

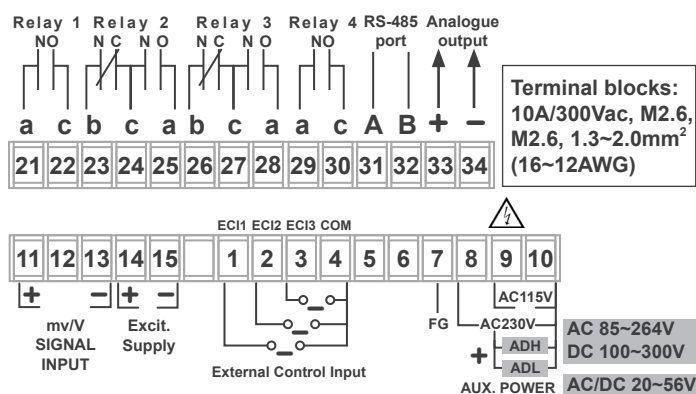

Please check the voltage of power supplied first, and then connect to the specified terminals. It is recommended that power supplied to the meter be protected by a fuse or circuit breaker.

## Power Connection

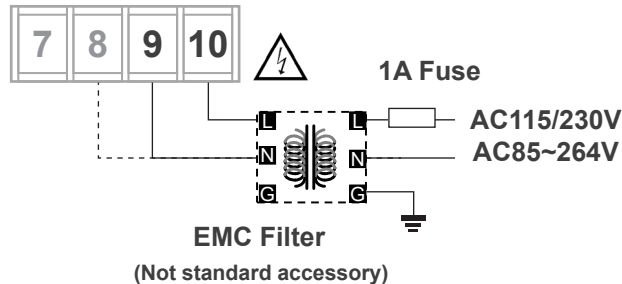

## Load Cell Connection

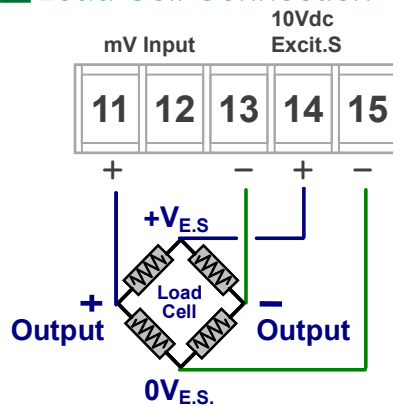

## RS-485 Communication Port

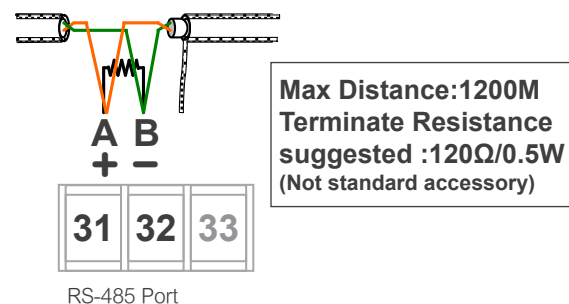

CS2-SG

## Function Description

### Input & Scaling Functions

**Input range:** Analogue input High and Low programmable

The meter has to be specified and fixed according to ordering code (ex. 0~2.0mV/V in factory. If the meter has to install in difference range of input, the meter can be set in function [R.L.O.] and [R.H.I.] of input group to meet the input signal.

For example: The meter is 0~2.0mV/V input, and the signal from sensor is 0~1.5mV/V. Please get into [INPUT GROUP] to set [R.H.I.] (Analogue input High) to be 75.00%(2.0mV/V x 75.00% = 1.5mV/V), then the meter has been changed the input range to 0~1.5mV/V and the all relative parameters will work base on 0~1.5mV/V. The meter doesn't need re-calibration after change the [R.L.O.] and [R.H.I.] .

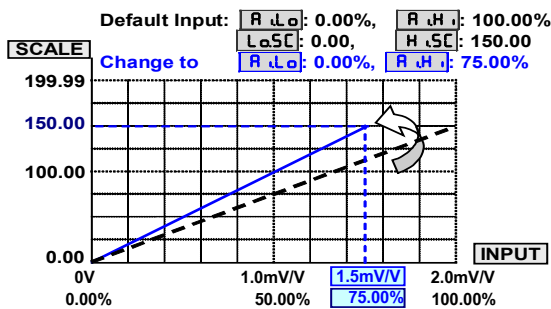

\*The setting may cause display lower resolution. Please set over resolution when the input signal has been high compressed.

### Scaling function:

Setting the [L.O.S.C.] (Low scale) and [H.S.C.] (High scale) in [INPUT GROUP] to relative input signal. Reverse scaling will be done too. Please refer to the figure as below,

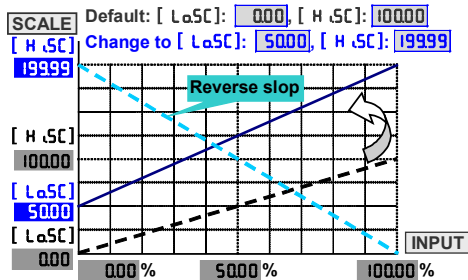

## Display & Functions

**Max / Mini recording:** The meter will storage the maximum and minimum value in [user level] during power on in order to review drifting of PV.

**Display functions:** PV / Max(Mini) Hold / RS 485 programmable in (Please refer to step A-07) [DISPLAY] function of [INPUT GROUP]

**Present Value [P.V.]:** The display will show the value that Relative to Input signal.

**Maximum Hold [M.H.] / Minimum Hold [M.H.]:** The meter will keep display in maximum(minimum) value during power on, until manual reset by front key in [User level], rear terminal is close [External Control Input(ECI)] or press front down or up key to reset (according to setting, please refer to the function of the ECI Group)

▶ Please find the [M.H.] sticker that enclosure the package of the meter to stick on the right side of square orange LED

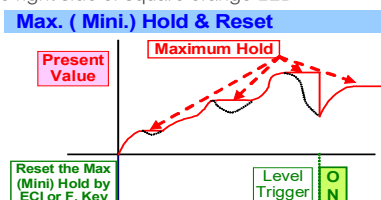

Remote Display by RS-485 command [-5485] :

The meter will show the value that received from RS-485 sending. In past, The meter normally receive 4~20mA or 0~10V from AO or digital output from BCD module of PLC. We support a new solution that PV shows the value from RS-485 command of master can so that can be save cost and wiring from PLC.

Other functions :

The meter is also support relative PV (ΔPV) and PV hold functions that set in [ ECI group]. Please refer to explain of ECI functions.

**Low cut:** Settable range from -19999~+99999 counts.

The users can set the value range.

1.If set the positive value (X1) here to display "0" which is expressed to be low-cut the PV between "+X1 (plus)" & "-X1(minus)" /absolute value  
 PV< I Setting value (X1) I, the display will be shown 0  
 EX: Low Cut is set for 0.50. If the display is from -0.50~+0.50, that will be 0.

**Low Cut set to be +0.50**

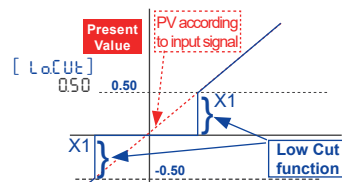

Low Cut is set for 0.50, if the PV is from -0.50~+0.50, that display will be 0.

2.If set the negative value (X2) here to display "X2" which is expressed to be low-cut the PV that it's under the X2 setting value;

PV< Setting value(X2), the display will be shown X2.

EX: Low Cut is set for -0.01. If the display is < -0.01, and all the display will be -0.01.

**Low Cut set to be -0.10**

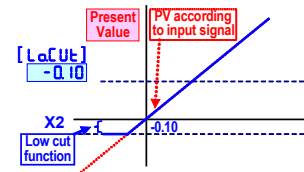

Low Cut is set for -0.10, if the PV is under (<= -0.10), that display will be -0.10.

**Digital fine adjust:** Settable range: -19999~+29999

Users can get Fine Adjustment for Zero & Span of PV by front key of the meter, and "Just Key In" the value which user want to show in the current input signals.

Especially, the [P.U.P.R.O.] & [P.U.S.P.N.] are not only in zero & span of PV, but also any lower point for [P.U.P.R.O.] & higher point for [P.U.S.P.N.]. The meter will be linearization for full scale.

The adjustment can be clear in function [P.S.C.L.R.]

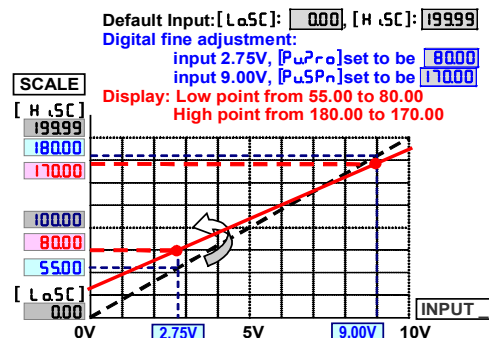

Reading Stable Function

Average display:

Jittery Display caused by the noise or unstable signal. User can set the times to average the readings, and to get smoothly display. The meter's sampling is 15cycle/sec. If the [ **AVG** ](Average) set to be **3** to express the display update with 5 times/sec. The meter will calculate the sampling 1-3 and update the display value. At meantime, the sampling 4-6 will be processed to calculate.

**Average set to be 3**



Display Update Value= (Sample 1+Sample 2+Sample 3)/3      Display Update Value= (Sample 4+Sample 5+Sample 6)/3

Remark: The higher average setting will cause the response time of Relay and Analogue output slower.

Moving average:

Jittery Display caused by the reasons as like as noise or unstable signal. User can set the times to average the readings, and get smoothly display. The meter's sampling is 15cycle/sec. If the [ **MAV** ](Moving Average) set to be **3** expressed the display update with 15 times/sec.

In the first updated display value will be same as average function. In the next updated display value, the function will get the new fourth sample (sample 4) then throw away the first sample (sample 1) that the newest 3 samples(sample 2,3,4) will be calculated for the updated display value.

**Moving Average set to be 3**



In first 3 samples, Display Update Value =(Sample 1+Sample 2+Sample 3)/3

Display Update Value=(Sample 2+Sample 3+Sample 4)/3

Display Update Value=(Sample 3+Sample 4+Sample 5)/3

Display Update Value=(Sample 4+Sample 5+Sample 6)/3

Remark: The higher moving average setting wouldn't cause the response time of Relay and Analogue output slower after first 3 samples.

Digital Filter: The digital filter can reduce the magnetic noise in field.

The digital filter can reduce the influence of spark noise caused by magnetic of coil.

If the values of samples are over digital filter band (fix in firmware and about 5% of stable reading) 3 times (Digital Filter set to be 3) continuously, the meter will admit the samples and update the new reading. Otherwise, it will be as treat as a noise and skip the samples.

Control Functions (optional)

Relay energized mode:Hi/ Lo/ Go-1.2/ Go-2.3/ Hi.HLd/ Lo.HLd/ DO programmable

Hi **[ H ]** (Fig.1- ): Relay will energize when PV > Set-Point

Lo **[ L ]** (Fig.1- ): Relay will energize when PV < Set-Point

**Hi / Lo Relay Energized Fig.1**

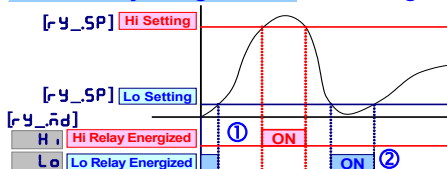

Go-1.2 **[ G-1.2 ]** : This function is programmable in Relay 4 only. If the Relay 4 set to be Go function, the relay will compare with **[ rYtSP ]** and **[ rYzSP ]**.

Go relay energized when the condition is **[ rYtSP ]** (Hi) > PV > **[ rYzSP ]** (Lo)

Go-2.3 **[ G-2.3 ]** : This function is programmable in Relay 4 only. If the Relay 4 set to be Go function, the relay will compare with **[ rYzSP ]** and **[ rYtSP ]**.

Go relay energized when the condition is **[ rYzSP ]** (Hi) > PV > **[ rYtSP ]** (Lo)

**Hi / Lo / Go Relay Energized**

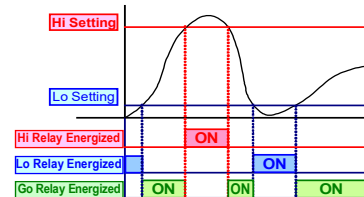

Hi.HLd **[ H.HLd ]** (Lo.HLd **[ L.HLd ]** ) :

The relay energized with latched function is for electrical safety and human protection.

For example, a current meter relay installed for the over current alarm of motor. Generally, over current of motor caused by over load, mechanical dead lock, aging of insulation and so on.

Above cases will alarm in the meter, if the user doesn't figure out the real reason and re-start the motor. It may damage the motor. The functions of Hi.HLd & Lo.HLd are designed must be manual reset the alarm after checking out and solving the issue. It's very important idea for electrical safety and human protection.

As the PV Higher (or lower) than set-point, the relay will be energized to latch except manual reset by from key in [ user level] or [ **EC** ](ECI) set to be **[ rYrSt ]** rYrst is closed.

**Hi(Lo) Energized Latch & Reset**

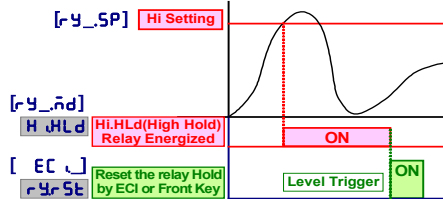

DO function **[ do ]** :The function has been designed not only a meter but also an I/O interface. In the case of motor control cabinet can't get the remote function. It's very easily to get the ON/OFF status of switch from CS2 series with RS-485 function.

If the **[ rY\_nD ]** had been set **[ do ]**, the relay will be energized by RS-485 command directly, but no longer to compare with set-point.

Start delay band and Start delay time:

The functions have Been designed for,

► To avoid starting current of inductive motor (6 times of rated current) with alarm.

► If the **[ rY\_nD ]** r relay\_energized mode had been set to be **[ L ]** (Lo) or **[ L.HLd ]** (Lo & latch). As the meter is power on and no input to display the "0" caused the relay will be energized. User can set a band and delay time to inhibit the energized of relay.

Start band **rYsb** (Fig.2- ): Settable range from 0~9999 Counts

Start delay time **rYsd** (Fig.2- ): Settable range from 0.0(s)~9(m)59.9(s);

**Start Delay Fig.2**

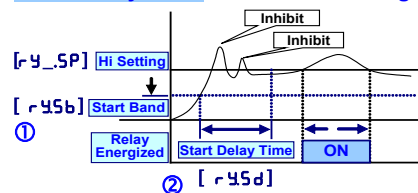



Hysteresis [y\_Hy] (Fig.3-①): Settable range from 0~9999 Counts

As the display value is swing near by the set point to cause the relay on and off frequently. The function is to avoid the relay on and off frequently such as compressor.....etc.,

Relay energized delay [y\_rd] (Fig.3-②): Settable range from 0.0(s)~9(m)59.9(s)

The function is to avoid the miss action caused by noise. Sometime, the display value will swing caused by spark of contactor...etc.. User can set a period to delay the relay energized.

Relay de-energized delay [y\_fd] (Fig.3-③): Settable range from 0.0(s)~9(m)59.9(s)

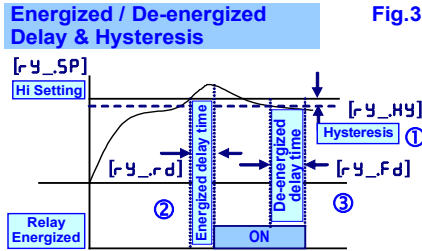

### External Control Inputs (ECI)

The three external control inputs are individually programmable to perform specific meter control or display functions. All E.C.I. have been designed in level trigger actions. Please pay attention, the ECI1 or ECI2 input will be disable while UP or Down Key has been set to be "YES".

Functions: Relative PV / PV Hold / Reset Max or Mini. Hold / DI / Reset for Relay Energized latch programmable.

Relative PV [rELPv] or Tare:

The [EC1] can be set to be [rELPv] function. When the E.C.I. is closed, the reading will show the differential value.

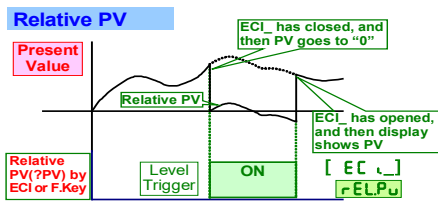

PV Hold [PvHld]:

The [EC1] can be set to be [PvHld] (PV Hold) function. The display will be hold when the ECI is closed, until the ECI is to be open. Please refer to the below figures

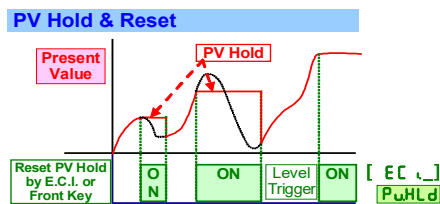

Reset for Maximum or Minimum Hold [r5t]:

When the [dSPly] function in [inPUt CrOP] selected [r5Hd] or [r5Hd], the display will show Maximum or Minimum value.

The [EC1] function can be set to be [r5t] function to reset the maximum and minimum value in [USEr LEdL] by terminals of ECI (close). Please refer to the figure as below.

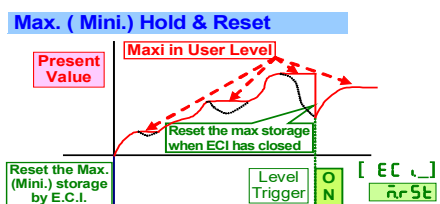

DI [di]:

The E.C.I can be set to be [di] function, when the meter building in RS-485 port. It is easier to get remote monitoring a switch status through the meter as like as DI of PLC.

Reset for Relay Energized Latch [y5t]:

If the relay energized mode has been set to be [H.HLd] (Energized latch), and the [EC1] can be set to be [y5t] (Reset the Relay energized latch). When the PV meets the condition of relay energizing, the relay will be energized and latch until the ECI is to be closed.

#### Hi(Lo) Energized Latch & Reset

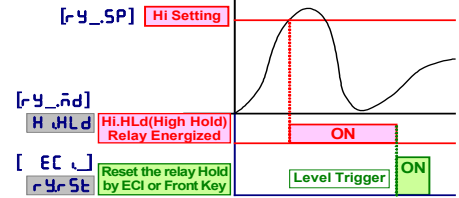

Debouncing time:

The function is for avoiding noise signal to into the meter. And The basic period is 8mseconds. It means you set the number that has to multiple 8 m-seconds.

For example: [dEBn] set to be 5, it means 5 x 8mseconds = 40mseconds

### Analogue Output (optional)

Please specify the output type either an 0~10V or 4(0)~20mA in ordering. The programmable output low and high scaling can be based on various display values. Reverse slope output is possible by reversing point positions.

Output range: Voltage: 0~5V / 0~10V / 1~5V programmable

Current: 0~10mA / 0~20mA / 4~20mA programmable

Functions: Output High / Low scale, output limit, fine adjustment

Output range high [RoH5]:

To setting the Display value High to versus output range High(as like as 20mA in 4~20)

Output range low [RoL5]:

To setting the Display value Low to versus output range Low(as like as 4mA in 4~20)

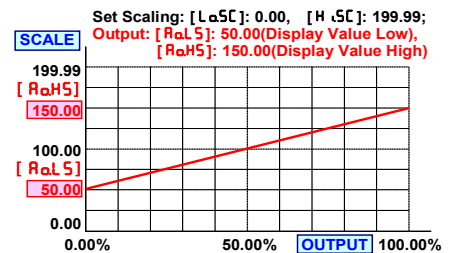

The range between [RoH5] and [RoL5] should be over 20% of span at least; otherwise, it will be got less resolution of analogue output.

Output High Limit [RoLnt]:

0.00~110.00% of output High User can set the high limit of output to avoid a damage of receiver or protection system.

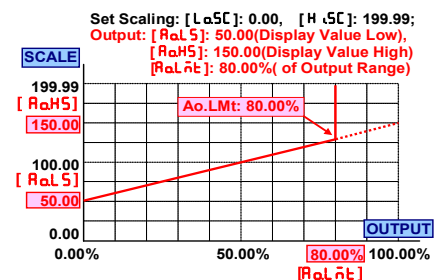

**Fine zero & span adjustment:**

Users can get Fine Adjustment of analogue output by front key of the meter. Please connect standard meter to the terminal of analogue output. To press the front key(up or down key) of meter to adjust and check the output.

Zero adjust [R0P0]: Fine Zero Adjustment for Analog Output; Settable range: -38011~27524;

Span adjust [R05P0]: Fine Span Adjustment for Analog Output; Settable range: -38011~27524;

**RS-485 Communication (optional)**

CS2 series supports Modbus RTU mode protocol to be used as Remote Terminal Unit (RTU) for monitoring and controlling in a SCADA (Supervisor Control And Data Acquisition) system. The baud rate can be up to 38400 bps. It's not only can be read the measured value and DI (external control inputs) status but also controls the relays output (DO) by RS-485 communication ports.

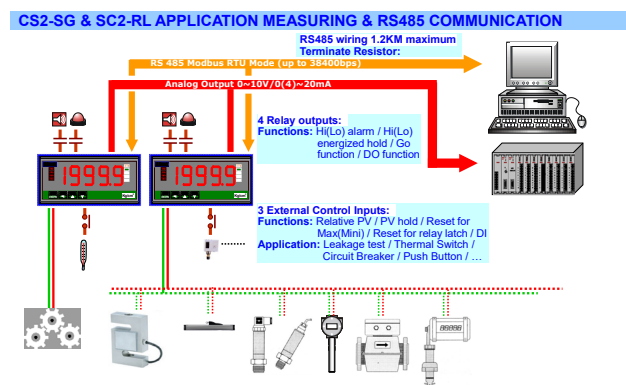

**Remote Display:**

The meter will show the value that received from RS-485 command. In past, The meter normally receive 4~20mA or 0~10V from AO or digital output from BCD module of PLC. We support a new solution that PV shows the value from RS-485 command of master so that can be save cost and wiring from PLC.

When the [ 45PL4 ] set to be RS-485, it means, the PV screen will show the number from RS-485 command & data. The data(number) will be same as PV that will compare with set-point, analogue output and ECI functions so that is to control analogue output, relay energized and so on.

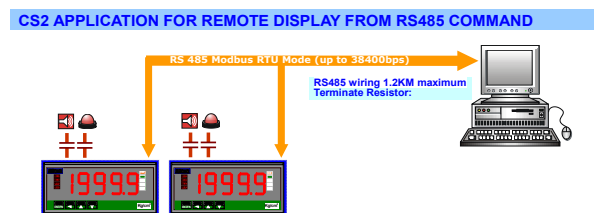

**Field Calibration:**

In pass time, engineers have take a lot of time to adjust meters or converter to meet the structure of machinery zero and span for the Load Cell measuring. Now, our CS2-SG support easier process to do it called "Field Calibration"

**Please accord to the numbers to do the field calibration (1 2 3 4 5 6)**

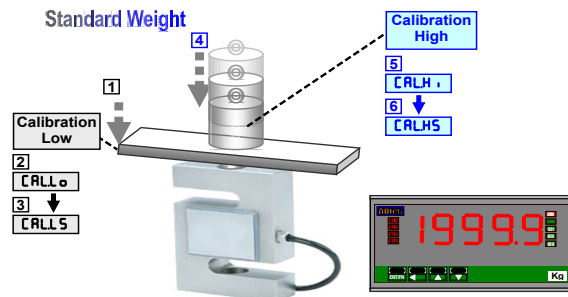

High Speed Mode: Code: -HSM

According the scaling, the controller can be specify higher sampling rate up to 60times/second(Average set to be 1). The relay trip, analogue output will be quicker response according to update of Present Value.

**Calibration**

System calibration by front key. The process of calibration, please refer to the operating manual.

CS2-SG

## Error Message

Before power on, please check the specification and connection again.

Self-diagnosis and error code:

DISPLAY	DESCRIPTION	REMARK
ouFL	Display is positive-overflow (Signal is over display range)	(Please check the input signal)
-ouFL	Display is negative-overflow (Signal is under display range)	(Please check the input signal)
ouFL	ADC is positive-overflow (Signal is higher than input range high 20%)	(Please check the input signal)
-ouFL	ADC is negative-overflow (Signal is lower than input range low -20%)	(Please check the input signal)
EEP ↔ FA.L	EEPROM occurs error	(Please send back to manufactory for repaired)
A.I.nG ↔ Pu	Calibrating Input Signal do not process	(Please process Calibrating Input Signal)
A.I. ↔ FA.L	Calibrating Input Signal error	(Please check Calibrating Input Signal)
AoC.nG ↔ Pu	Calibrating Output Signal do not process	(Please process Calibrating Output Signal)
AoC ↔ FA.L	Calibrating Output Signal error	(Please check Calibrating Output Signal)

## Front Panel

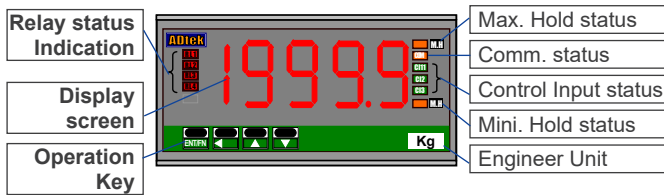

### Numeric Screens

0.8"(20.0mm) red high-brightness LED for 4 2/3 or 5 digital present value.

- I/O Status Indication
- Relay Energized: 4 square red LED
  - RL1** display when Relay 1 energized
  - RL2** display when Relay 2 energized
  - RL3** display when Relay 3 energized
  - RL4** display when Relay 4 energized
- External Control Input Energized: 3 square green LED
  - EC11** display when E.C.I. 1 close(dry contact)
  - EC12** display when E.C.I. 2 close(dry contact)
  - EC13** display when E.C.I. 3 close(dry contact)
- RS-485 Communication: 1 square orange LED
- COM** will flash when the meter is receive or send data, and **COM** flash quickly means the data transient quicker.
- Max/Mini Hold indication: 2 square orange LEDs
- M.H** displayed: When the display function has been selected in Maximum or Minimum Hold function.

### Stickers

Each meter has a sticker what are functions and engineer label enclosure.

- Relay energized mode: **HN** **Hi** **Lo** **LL** **DO**
- E.C.I. functions mode:
  - PV.H** PV.H(PV Hold) / **Tare** Tare / **DI** DI(Digital Input)
  - M.RS** M.RS(Maximum or Minimum Reset) /
  - R.RS** R.RS(Reset for Relay Latch)
- Engineer Label: over 80 types

## Operating Key

4 keys for **ENTER** Enter(Function) / **ESC** Shift(Escape) / **UP** Up key / **DOWN** Down key

	Setting Status	Function Index
<b>UP</b> Up key	Increase number	Go back to previous function index
<b>DOWN</b> Down key	Decrease number	Go to next function index
<b>ESC</b> Shift key	Shift the setting position	Go back to this function index, and abort the setting
<b>ENTER</b> Enter/Fun key	Setting Confirmed and save to EEPROM	From the function index to get into setting status

Pass Code **P.CoDE** : Settable range: 0000~9999;

User has to key in the right pass word so that get into **[ Programming Level ]** . Otherwise, the meter will go back to measuring page. If user forgets the password, please contact with the service window.

### Function Lock

- None **nonE** : no lock all.
- User Level **USER** : User Level lock. User can get into User Level for checking but setting.
- Programming Level **ENG** : Programming level lock. User can get into programming level for checking but setting.
- ALL **ALL** : All lock. User can get into all level for checking but setting.

### Front Key Function

- The **UP** Key can be set to be the same function as the setting of EC11.
  - Ex. The EC11 set to be **PuHLd** and the function **[E.I:UP]** set to be **YES** in **[ EC , GRoup ]**. When user presses **UP** Key, the PV will hold as like as EC11 close.
- The **DOWN** Key can be set to be the same function as the setting of EC12.
  - Ex. The EC12 set to be **-ELPu** and the function **[E.I:dn]** set to be **YES** in **[ EC , GRoup ]**. When user presses **DOWN** Key, the PV will show relative value as like as EC12 close.
  - If the front key function has been set, the terminal input for ECI will be disabling.



Operating Diagram

User Level (5Digi-Display Max range : 99999)

Power ON

Press for 1 sec. can back to Measuring



Programming Level(5Digi-Display Max range : 99999)

Press for 1 sec. can back to Measuring

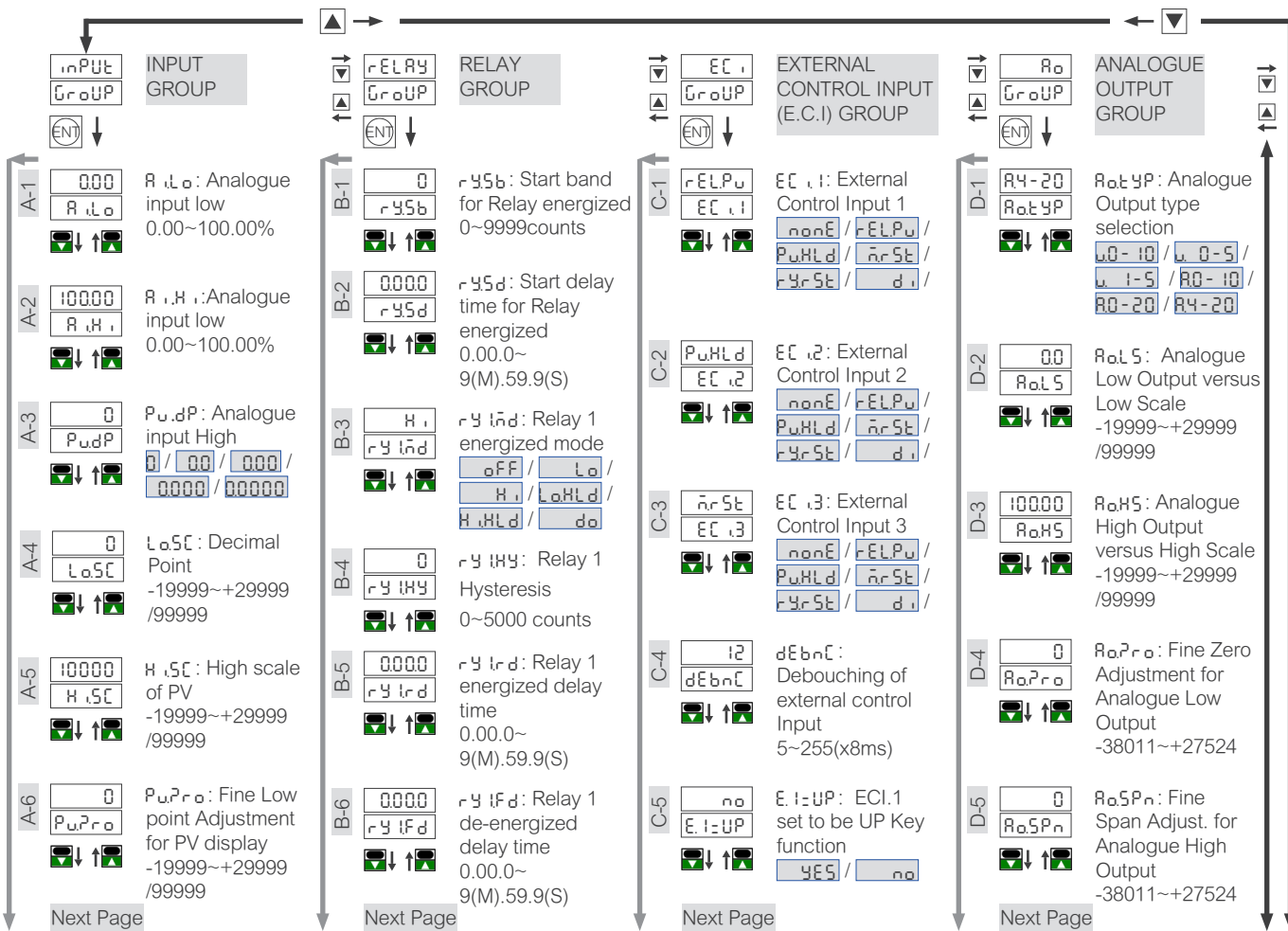

CS2-SG

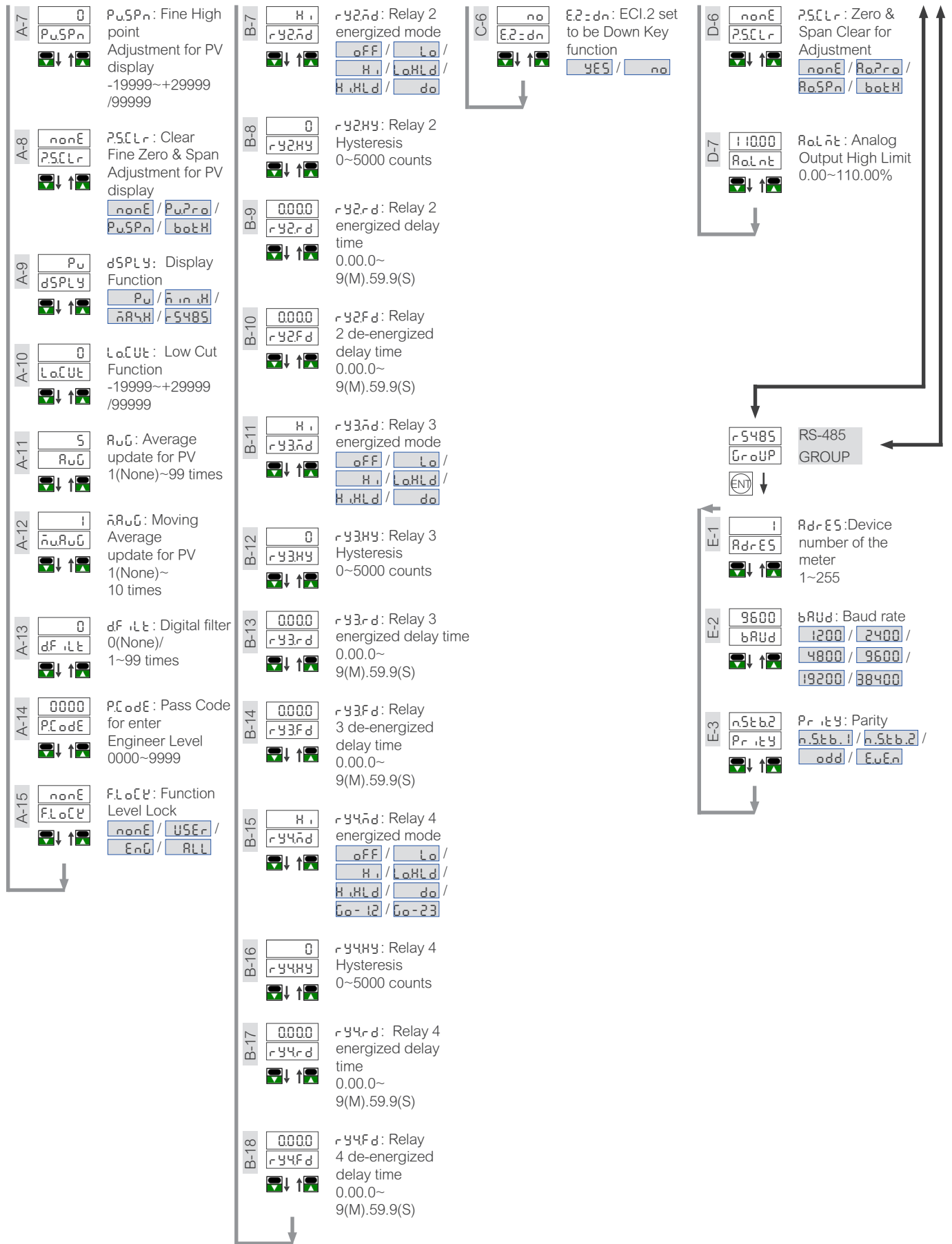

► Please refer to operating manual for detail description

## Field Calibration

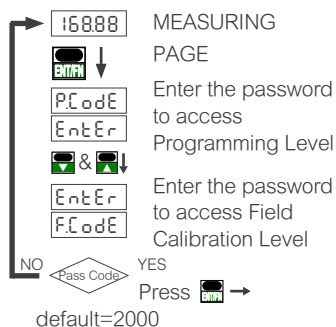

Once the user select field calibration, the [LoSc](step A-2) and [HSc](A-3) will be instead of [RLS] and [RLH], and can not to be change. If user has to change the scaling, it's the only way to access field calibration level to set in [RLS](step F-2) and [RLH](step F-4).

Please double check the [LoSc](step A-2) and [HSc](A-3) are correct after selection the **dEFLd** or **F.iELd**.

- F-1** Adjust the structure to be a lower signal output status (or any lower status) and keep it in stable.  
**[RLLo]**: Field Calibration Low  
 » Press to read signal of the lower status.  
 » Press again to finish the calibration lower point, and go to next page.
- F-2** **[RLLS]**: the value to be set is relative to Field Calibration lower point  
 » Press to set the value of lower scale.
- F-3** Adjust the structure to be a higher signal output status (or any higher status) and keep it in stable.  
**[RLH.]**: Field Calibration High  
 » Press to read signal of the higher status.  
 » Press again to finish the calibration higher point, and go to next page.
- F-4** **[RLHS]**: the value to be set is relative to Field Calibration higher point  
 » Press so set the value of Higher scale
- F-5** **[CSEL]**: Calibration parameter selection  
 » Press to access the function and stand by selection  
 » Press or to select  
 (default: **dEFLd**);  
 Settable: **dEFLd** / **F.iELd**  
**dEFLd** (default calibration) **F.iELd** (Field calibration)

CS2-SG